

## Determination of the Load Applied to Bale Wrapping Machine Rotary Arm and Performing of Design Optimization

Soner Duran<sup>1</sup>, Yasin Coşkun<sup>1</sup>, Derya Kılıç<sup>1</sup>, Ahmet Uyumaz<sup>2\*</sup>, Batuhan Zengin<sup>2</sup>

<sup>1</sup> Kayhan Ertuğrul Machinery R & D Department, Burdur, 15040, Turkey

<sup>2</sup> Mechanical Engineering Department, Faculty of Engineering and Architecture, Burdur Mehmet Akif Ersoy University, Burdur, 15030, Turkey

### ABSTRACT

In this study, it was aimed to determine the optimum design for bale wrapping machine rotary arm. Determination of the force has been ensured by determining of the hydraulic motor outlet pressure acting the bale wrapping arm and verifying these values with the help of mathematical equations. It was targeted to decrease the displacement and stress values via the changing of bale wrapping arm pipe thickness (6,5,4,3 and 2 mm) that does not restrict the machine's mobility. Static constructional analyses of different arm designs have been conducted with Ansys Workbench simulation program. Maximum displacement values were determined as 2.2677, 2.9035, 3.9552, 6.0299 and 11.636 mm with 6,5,4,3 and 2 mm pipe thickness respectively. Maximum stress values were obtained as 20.196, 26.651, 36.453, 55.491 and 98.806 MPa with 6,5,4,3 and 2 mm pipe thickness respectively. It can be suggested that 3mm pipe thickness could be safely used for rotating arms. It was seen that maximum stress and displacement values decreased with the increase of pipe thickness.

**Keywords:** Bale Machine Wrapping Arm, Design, Optimization, Stress

#### History

Received: 05.10.2021  
Accepted: 14.12.2021

#### Author Contacts

\*Corresponding Author

e-mail addresses : [sonerduran@kayhanertugrul.com.tr](mailto:sonerduran@kayhanertugrul.com.tr) , [yasincoskun@kayhanertugrul.com.tr](mailto:yasincoskun@kayhanertugrul.com.tr) , [deryakilic@kayhanertugrul.com.tr](mailto:deryakilic@kayhanertugrul.com.tr) , [ayumaz@mehmetakif.edu.tr](mailto:ayumaz@mehmetakif.edu.tr)\*, [bthnzngn197@gmail.com](mailto:bthnzngn197@gmail.com)

Orcid numbers : 0000-0001-7531-909X<sup>1</sup>, 0000-0002-3820-7934<sup>1</sup>, 0000-0002-2018-0657<sup>1</sup>, 0000-0003-3519-0935<sup>2\*</sup>, 0000-0001-9217-7839<sup>2</sup>

<http://dx.doi.org/10.29228/eng.pers.55670>

### 1. Introduction

Livestock has a significant importance over the development of agriculture sector and it changes according to the increment on usage ability of the technology of the small business in parallel. Furthermore, small business channel into silo feeds, which are cheap and qualified, provides more economical production opportunities [1].

The water and nutrition content on qualified food is important. For that reason, the silage is the leading of coarse fodder. Silage meets the feed needs of ruminants such as cattle, sheep and goats. It is obtained as a result of fermentation with the effect of lactic acid bacteria by leaving the high moisture feeds stored in the silos in the oxygen-free environment [2]. It is the only succulent and economical coarse fodder which can be provided while in winter time [3]. One of the main factors of production of qualified feed is the usage of technology. Harvest is the leading of the stages that is used technology on the production of coarse fodder. Baling which is used while harvesting is a process providing storage of the stalks and forage crops in lowest stage and shortest time without any defect [4].

Silage production is important in our country because the meadow fields are limited, the grazing season is limited and the need for roughage in the winter months is an important problem. If the coarse fodder is succulent in winter time, the productivity of the animals is kept along whole year. In the seasons which have abundant of succulent feeds, silage is obtained by ensiling the surplus of grass along with the pulse, gramine, forage crops and leftovers of industrial crops.

Silage provides the animals to be feed in well and economical when no succulent feeds are not in winter seasons. It reduces the cost of storage and storing problems. 15 tons of green crops can be stored in place of 2 tons of dry crops. The crops for silage can be harvested in short time and provides suitable time for the next cultivation.

With the drying of the green crops, leafery and stalks go down. Since the stalks have been dried, they are not eaten by the animals willingly. But in ensiling, no lose on the food value of the feeds and they are eaten eagerly. The crop which will be converted to silage need to be harvested in the time when the quality of the crop and its ensiling ability is maximum. During harvesting, need to be cared that stone, soil, wire etc. will not mix in the crop. The humidity of

the plant is very important. The lower or higher humidity in the plant may reduce the quality of the silage and cause decomposition. If no water comes out when the crop is crushed but humidity is felt in the hand, it means that humidity rate is among 60-67%, so the fodder can safely be ensiled [5-6].

Although the performance of silage wrapping has been comprehensively studied by some scientists [7-9], studies on parameter optimization for a cylindrical bale wrapping machine are so rare. In order to support the development on silage technology of the bales made by grass, clover, corn etc., a drum type cylindrical bale wrapping machine based on wrapping silage with stretch film (the drum drives the stretch film to rotate around the round bale, while the carrier rollers move the round bale to rotate) can be designed and arranged according to round bales of different characteristics.

In this study, with the theoretical analysis and experimental study on the wrapping arm of the bale wrapping machine, the round bale wrapper of grass, clover, corn etc., static structural analysis has been carried out on the arm by considering the maximum torque and pressure values which will be applied by the hydromotor. The arm of the bale wrapper is mounted with a flanged and bolted connection to the part where the hydromotor moves, Optimum arm design is aimed by examining the tensile and displacement of the pipe.

**2. Material and Method**

The rotational movement required for the arms of the bale wrapping machine is provided with the help of a fixed displacement hydromotor. The technical specifications of the hydromotor are given in Table 1.

Table 1. The technical specifications of the hydromotor

Displacement (cm <sup>3</sup> )	158.7
Nominal pressure (bar)	140
Maximum pressure (bar)	210
Maximum torque (Nm)	307
Maximum speed (rpm)	380

The schematic representation of the arm system of the bale wrapping machine is shown in Figure 1.

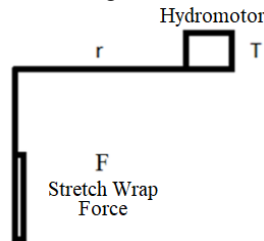

Figure 1. The schematic representation of the arm system of the bale wrapping machine

In the study, static structural analysis was carried out on the arm, taking into account the maximum torque and pressure values to be applied by the hydromotor. The arm of the bale wrapping machine is mounted to the part where the hydromotor moves, with flange and bolted connection. In this study, it is aimed to design the optimum arm by examining the tension and displacement of the pipe.

Figure 2 shows the rotating arm of the bale wrapping machine. Figure 3 shows the position of the hydromotor and the rotating wrapping arms.

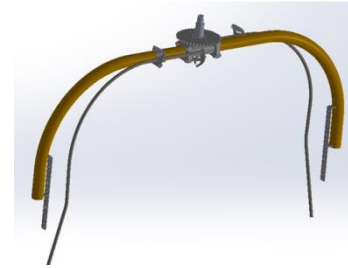

Figure 2. Rotating arm of the bale wrapping machine

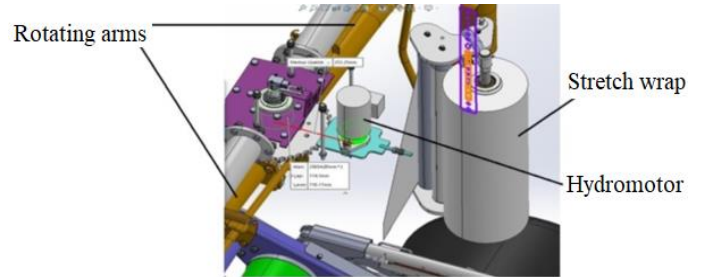

Figure 3. Position of the hydromotor and the rotating wrapping arms

The Eq.(1) is used to calculate the torque value produced by the hydromotor. In Eq.(1),  $V$  denotes engine displacement (cm<sup>3</sup>),  $\eta_{mh}$  denotes hydromechanical efficiency, and  $\Delta P$  (bar) denotes pressure difference.

$$M_{ab} = \frac{\Delta P \cdot V \cdot \eta_{mh}}{20 \cdot \pi} \tag{1}$$

Calculation of power (kW) is performed by Eq.(2).  $Q$  in the equation gives the flow rate (l/min),  $\eta_{ges}$  gives the total efficiency.

$$P_{ab} = \frac{\Delta P \cdot Q}{600 \cdot \eta_{ges}} \tag{2}$$

The determination of the system flow rate is done with the help of Eq.(3). Here  $\eta_v$  represents the volumetric efficiency and  $n$  represents the hydromotor speed.

$$Q = \frac{n \cdot V \cdot \eta_v}{1000} \tag{3}$$

The force acting on the vertical of the bale wrapping arm is determined by dividing the maximum torque the hydromotor is exposed to by the arm length. The calculation of this force value is provided by Eq.(4). Centrifugal force of the rotating arms was also computed.

$$F = \frac{T}{r} \tag{4}$$

**2.1 Designing of the different rotating arms**

One of the most important design parameters for rotating arm in the bale wrapping machine is the pipe thickness. The outer diameter of the original produced pipe used is 90 mm and the thickness is

5 mm. Static structural analysis was carried out in 5 different pipe thicknesses (2, 3, 4, 5 and 6 mm) in order to determine the maximum stress and displacement amounts that may occur in the arm depending on the force applied to the arm during the wrapping of the bale and to improve the design. While the rotating arms are being designed, the 32 kg stretch required for wrapping the bale is included in the design. Weight of the stretch was considered in the analysis. St 37 steel was used as the pipe material. Mechanical and physical properties of St 37 steel are given in Table 2. The technical drawing dimensions of the rotating arm of the bale wrapping machine are given in Figure 4.

### 2.2 Analysis

Rotating arms with different pipe thicknesses are modeled in Solidworks program. Then, the rotating arms in the Ansys Workbench program were subjected to static analysis. In the analysis, first of all, St 37 steel material assignment was performed on the program. The mesh layer was created in the Ansys program of the rotating arm, which was previously designed in five dimensions.

Table 2. Some mechanical and physical properties of St 37 steel (S235JR) [10-13]

Density (kg/m <sup>3</sup> )	7800
Modulus of elasticity (MPa)	210000
Elongation (%)	22
Tensile strength (MPa)	360
Yield strength (MPa)	235
Poisson ratio	0.28

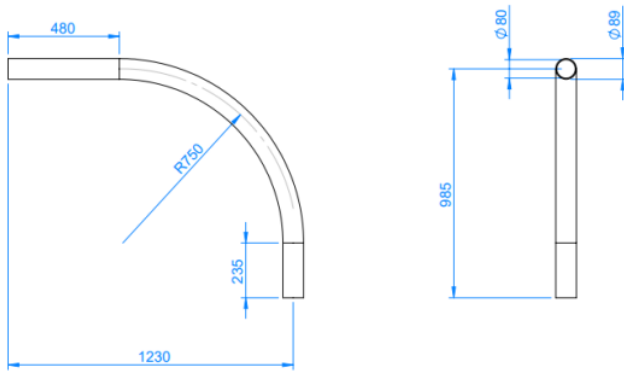

Figure 4. Technical drawing dimensions of the rotating arm of the bale wrapping machine

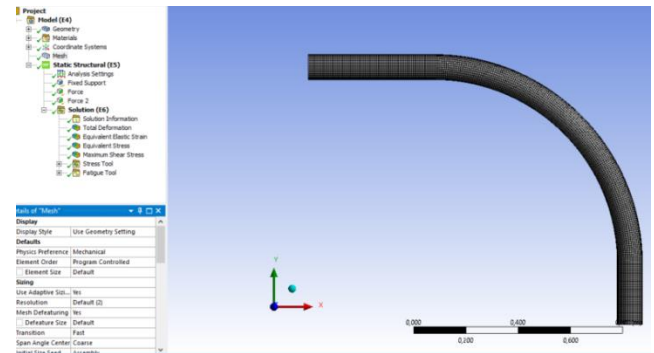

Figure 5. Mesh structure

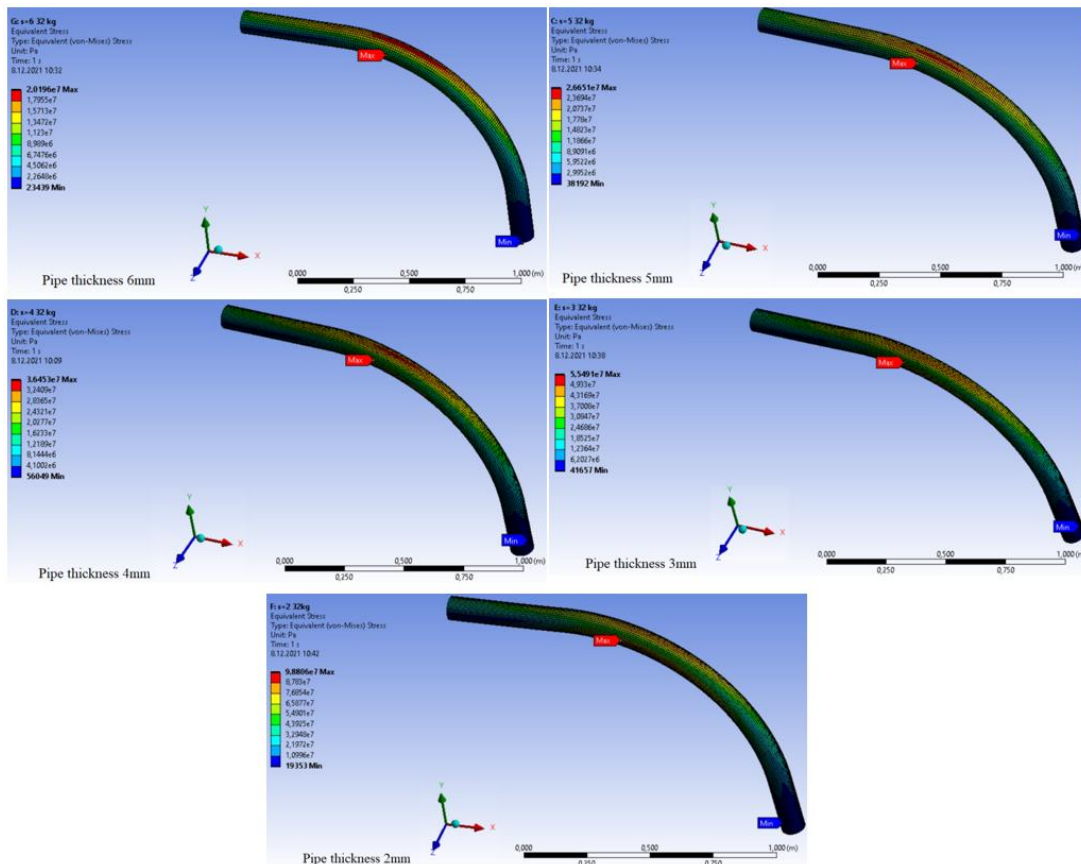

Figure 6. Total deformations in rotating arms with different pipe thickness

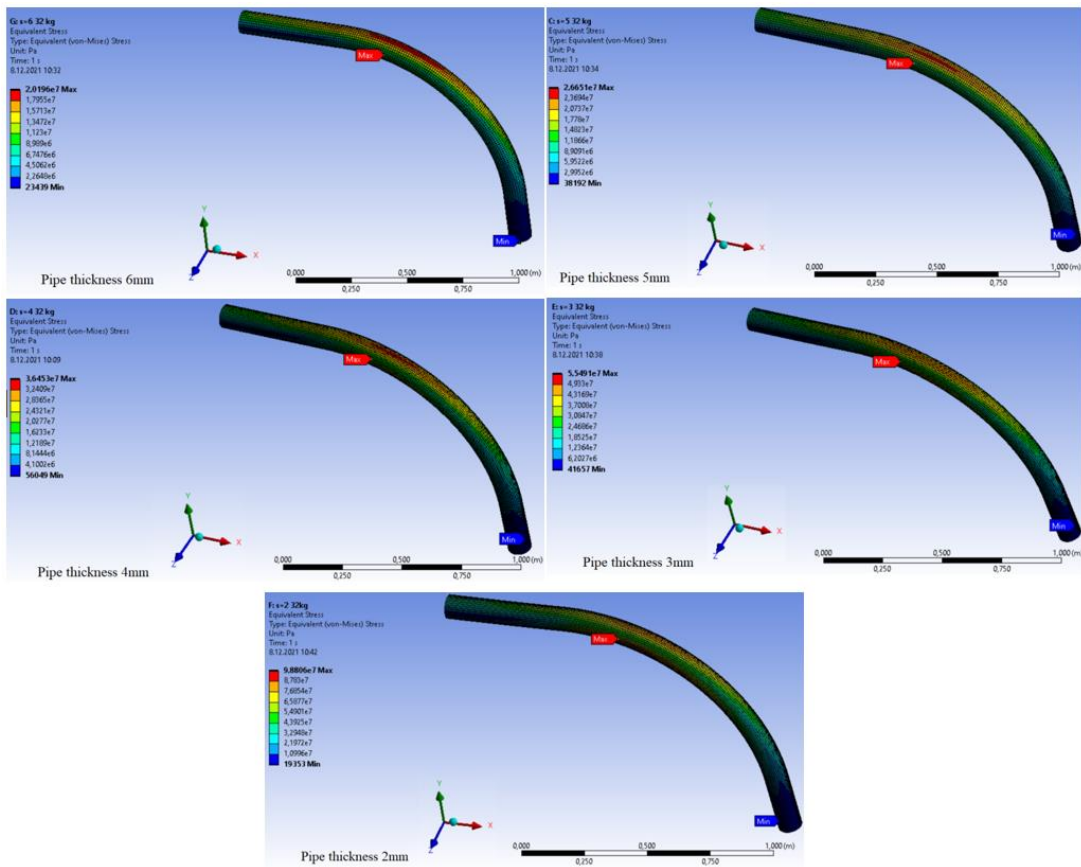

Figure 7. Stress changes in rotating arms with different pipe thicknesses

The mesh structure was obtained as shown in Figure 5. In the model with a mesh structure, the rotating arm was fixed in the flange side where hydromotor was mounted to rotate the arms. The force to be applied to the rotating wrapping arm was determined by considering the maximum operating pressure, torque of the hydromotor and the force that comes to the stretch wrap during the movement of the machine using the above-mentioned equations. 1009.7 N force was applied to the rotating arm in the form of a distributed load. A total of 52995 nodes and 7854 elements were created in the model for 5mm pipe thickness.

### 3. Results and Discussion

Depending on the weight of the bale and the stretch, the force on the rotating arm was applied as a distributed load. Depending on the force on the rotating arm, problems arise in the machine and different deformation problems can be seen. In order for the rotating arm to do its job in the best way, its strength should be increased. At this point, the thickness of the pipe has been changed for the optimization of the rotating arm driven by the hydromotor. For five different pipe thicknesses, points and amounts of maximum deformation, minimum and maximum stresses were examined. Figure 6 shows the total deformation of the rotating arms with different pipe thicknesses.

As seen in Figure 6, the minimum displacement is seen on the flange side where the hydromotor is connected. Maximum deformation was observed in the part where the stretch to which the load is applied is connected. It is seen that the maximum deformation

decreases as the pipe thickness of the rotating arm increases.

During the wrapping of the bale, the force applied to the stretch and the rotating arm may cause bending and deformation of the rotating arm. At this point, the bale cannot be effectively wrapped with a stretch. Figure 7 shows the points where the minimum and maximum stress occurs. In addition, the amounts of the minimum and maximum stresses in the rotating arm with different pipe thicknesses have been also given. It is seen that the minimum stress in the rotating arms is observed where the stretch is attached. It is seen that the maximum stress in all rotating arm designs is in the bending part of the pipe. In the analysis results, it is seen that the maximum stress decreases as the pipe thickness increases. Table 3 shows the minimum and maximum displacement and stress values obtained in the designed rotating arms.

Table 3. Minimum and maximum displacement and stress values obtained in the designed rotating arms

Pipe thickness (mm)	Maximum displacement (mm)	Minimum Stress (MPa)	Maximum Stress (MPa)	Maximum Shear Stress (MPa)
6	2.2677	0.0235	20.196	11.658
5	2.9035	0.0319	26.651	15.321
4	3.9552	0.0560	36.453	20.747
3	6.0299	0.0416	55.491	30.805
2	11.636	0.0194	98.806	52.846



#### 4. Conclusions

In this study, the design optimization of the rotating arms of the bale wrapping machine has been carried out. Without changing the length and radius dimensions of the rotating arms, the rotating arms with pipe thicknesses of 6,5,4,3 and 2 mm were modeled. The force applied to the stretch and rotating arm during the wrapping of the bale was determined. The determined force was applied to the rotating arms. Structural static analyzes of the designed rotating arms of different sizes were carried out in the Ansys Workbench program. Analysis results showed that the amount of deformation decreases as the pipe thickness of the rotating arm of the winding machine increases. Maximum deformation is seen with the rotating arm with a pipe thickness of 2 mm. In addition, the analysis shows that the maximum stress decreases as the pipe thickness increases. As a result of the study, the stresses occurring in the rotating arm of the bale wrapping machine were determined and the optimum rotating arm design was tried to be determined. Safety factor has been determined as 8.817, 6.446, 4.234 and 2.378 for 5, 4, 3 and 2 mm pipe thickness. It can be suggested that 3mm pipe thickness could be safely used for rotating arms. It has been observed that as the pipe thickness increases, the stresses occurring in the rotating arm decrease and the pipe strength can be increased.

#### Acknowledgment

This study is supported by Kosgeb (Small and Medium Enterprises Development and Support Administration) in frame of the project name of Design and Development of Trailed Type Roll Baler carried out by Kayhan Ertuğrul Machinery Industry and Trade Inc. Aş researchers; we thank the KOSGEB and KAYHAN ERTUĞRUL MACHINERY INDUSTRY and TRADE INC.

#### Nomenclature

$M_{ab}$	:Torque of hydromotor (Nm)
$\Delta P$	:Pressure difference (bar)
$V$	:Displacement (cm <sup>3</sup> )
$\eta_{mh}$	:Hydromechanical efficiency
$P_{ab}$	: Engine power (kW)
$Q$	: Flow rate (L/min)
$\eta_{ges}$	: Total efficiency
$n$	: Hydromotor speed (rpm)
$\eta_v$	: Volumetric efficiency
$F$	: Force (N)
$T$	: Torque (Nm)

#### Conflict of Interest Statement

The authors declare that there is no conflict of interest in the study.

#### CRedit Author Statement

**Soner Duran:** Project administration, Data curation, Formal analysis, Methodology, Funding acquisition **Yasin Coşkun:** Conceptualization, Supervision, Funding acquisition, Investigation, Resources, **Derya Kılıç:** Conceptualization, Supervision, Funding acquisition, Roles/Writing –original draft, Resources **Ahmet Uyumaz:** Writing-review&editing, Conceptualization, Methodology, Investigation, Supervision, **Batuhan Zengin:** Data curation, Investigation, Visualization, Validation, Software

#### References

1. Bilgen H, Yalçın H, Özkul H, Çakmak B, Polat M, Kılıç A (2005). The effects of plastic color, vacuum implementation and holding method on the quality of packaged corn silage feed. *Ege Üniversitesi Ziraat Fakültesi Dergisi*, 42(2), 77-85.
2. Wood, Brian J. B. *Microbiology of fermented foods Volume 1&2*. Springer. s. 73.
3. Geren H., Avcıoğlu R., Kır B., Et Al. (2003). The Effect of Different Seed Times on Yield and Quality Features in Some Corn Varieties Cultivated as Second Crop Silage. *Ege Üniversitesi Ziraat Fakültesi Dergisi*, 40(3):57-64.
4. Ayık, M. (1993). *Hayvancılıkta Mekanizasyon*. (II.Baskı). Ankara Üniversitesi Ziraat Fakültesi Yayınları: 1300. Ders Kitabı 375, Ankara).
5. Muck, R. E., Nadeau, E. M. G., McAllister, Et Al. (2018). Silage review: Recent advances and future uses of silage additives. *Journal of dairy science*, 101(5), 3980-4000.
6. McDonald, P., Henderson, A. R., Heron, S. J. E. (1991). *The biochemistry of silage*. Chalcombe publications.
7. Martinson K, Coblentz W, Sheaffer C. (2011). The effect of harvest moisture and bale wrapping on forage quality, temperature, and mold in orchard grass hay. *Journal of Equine Veterinary Science*, 31(12): 711–716.
8. Coblentz W K, Coffey K P, Chow E A. (2016). Storage characteristics, nutritive value, and fermentation characteristics of alfalfa packaged in large-round bales and wrapped in stretch film after extended time delays. *Journal of Dairy Science*, 99(5): 3497–3511.
9. Taylor, R. K., Blasi D A, Shroyer J P. (1994). Storage losses in net-wrapped, large round bales of alfalfa. *Applied Engineering in Agriculture*, 10(3): 317–320.
10. Taşkaya, S. (2018). St 37 Çeliğinin Ansys Programında Basınca Bağlı Olarak Mekanik Gerilmelerin İncelenmesi. *The Journal of International Manufacturing and Production Technologies*. 39-46.
11. <https://www.esb-group.com/en/products-din-en/structural-grade-carbon-steel/>
12. <https://metalitec.zriha.com/eng/raw-materials/st37>